

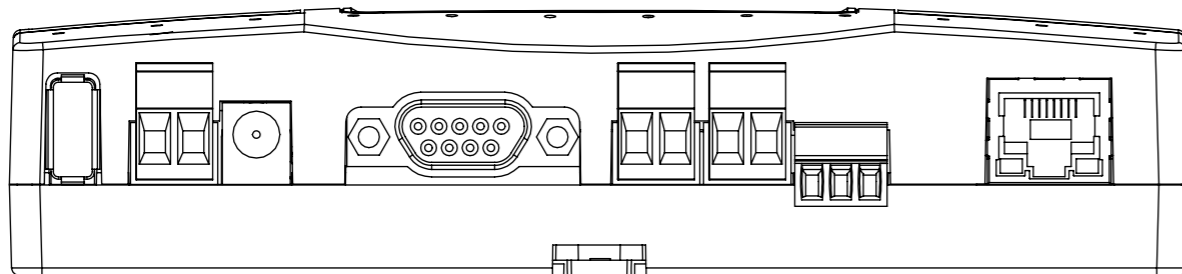

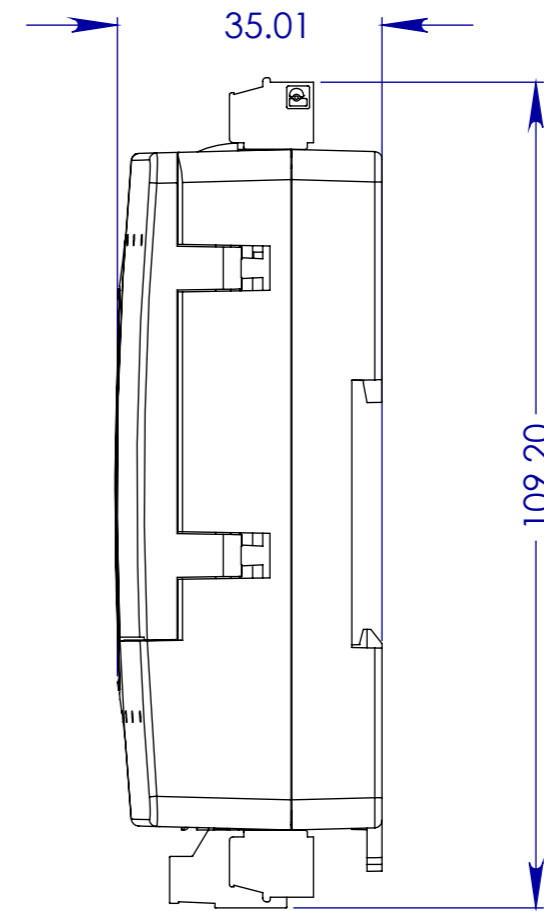

FOR REFERENCE ONLY  
 PRODUCTION ACCORDING TO 3D FILES ONLY

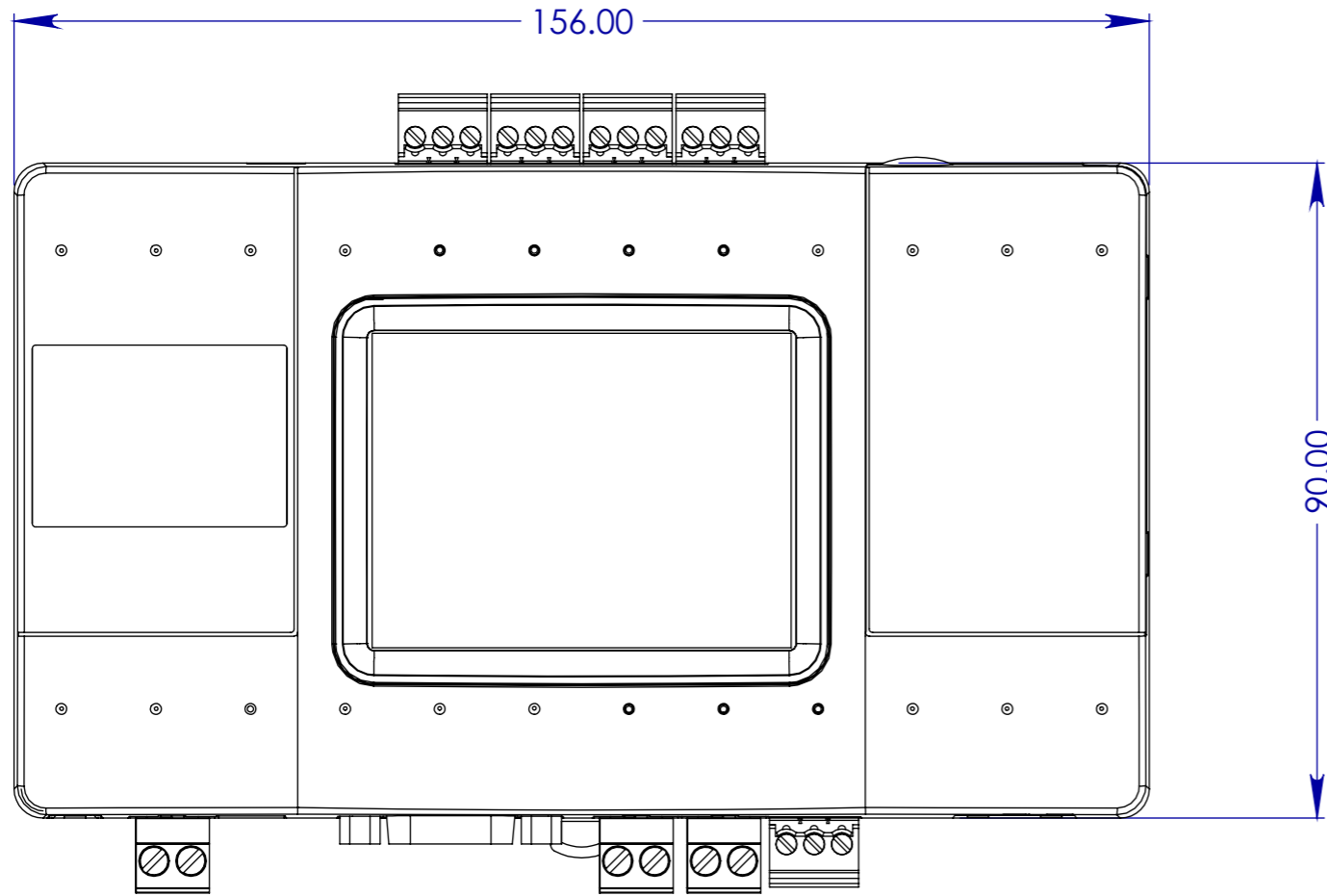

<b>General Tolerance:</b> 0 - 120 mm: ±0.1mm 120 - 350 mm: ±0.2mm 350 - 1000 mm: ±0.5mm Angles: ±1° Between Holes: ±0.15mm All Dimensions Are In: mm	<b>Material:</b> <b>Finish:</b>																							
	<table border="1"> <thead> <tr> <th>Position</th> <th>Name</th> <th>Signature</th> <th>Date</th> </tr> </thead> <tbody> <tr> <td>Designed By:</td> <td>CoolAutomation</td> <td></td> <td>01/09/13</td> </tr> <tr> <td>Drawn By:</td> <td>Yehuda Klein</td> <td></td> <td>01/09/13</td> </tr> <tr> <td>Checked By:</td> <td>Alexander Troitsky</td> <td></td> <td>01/09/13</td> </tr> <tr> <td>ENG Appr.:</td> <td>Alexander Troitsky</td> <td></td> <td>01/09/13</td> </tr> </tbody> </table>					Position	Name	Signature	Date	Designed By:	CoolAutomation		01/09/13	Drawn By:	Yehuda Klein		01/09/13	Checked By:	Alexander Troitsky		01/09/13	ENG Appr.:	Alexander Troitsky	
Position	Name	Signature	Date																					
Designed By:	CoolAutomation		01/09/13																					
Drawn By:	Yehuda Klein		01/09/13																					
Checked By:	Alexander Troitsky		01/09/13																					
ENG Appr.:	Alexander Troitsky		01/09/13																					
	<b>Unless Otherwise Specified:</b> - Break sharp corners and edges 0.2mm max. - Fillet radius 0.4mm MAX - C'sink int. threads 90° to major DIA - Chamfer ext. threads 45° to minor DIA		<b>Confidential</b> This publication contains proprietary information of Cool Control Ltd. It is provided to those concerned with the operation and maintenance of the equipment covered therein, and may not be disclosed to others without the express written permission of Cool Control Ltd.		<b>Do Not Scale Drawing</b>																			
SI METRIC	<b>SCALE: 1:1</b>	<b>SHEET: 1 OF: 2</b>	<b>SIZE: A3</b>	<b>Rev: 2</b>																				

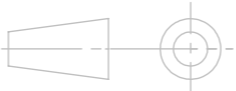
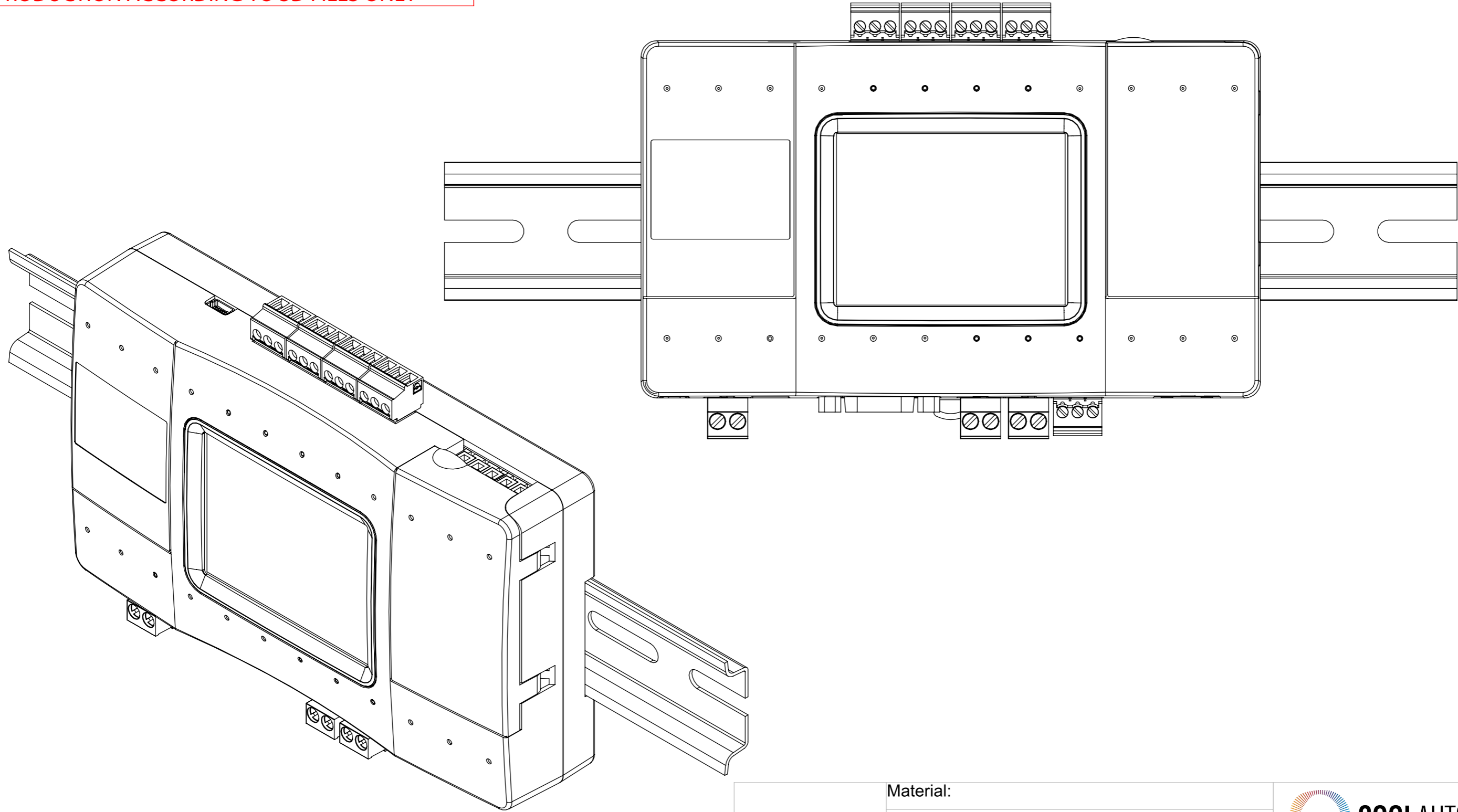
**FOR REFERENCE ONLY  
PRODUCTION ACCORDING TO 3D FILES ONLY**

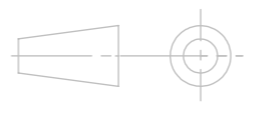

<b>General Tolerance:</b> 0 - 120 mm: ±0.1mm 120 - 350 mm: ±0.2mm 350 - 1000 mm: ±0.5mm Angles: ±1° Between Holes: ±0.15mm All Dimensions Are In: mm	<b>Material:</b> <b>Finish:</b>																					
	<table border="1"> <thead> <tr> <th>Position</th> <th>Name</th> <th>Signature</th> <th>Date</th> </tr> </thead> <tbody> <tr> <td>Designed By:</td> <td>CoolAutomation</td> <td></td> <td>01/09/13</td> </tr> <tr> <td>Drawn By:</td> <td>Yehuda Klein</td> <td></td> <td>01/09/13</td> </tr> <tr> <td>Checked By:</td> <td>Alexander Troitsky</td> <td></td> <td>01/09/13</td> </tr> <tr> <td>ENG Appr.:</td> <td>Alexander Troitsky</td> <td></td> <td>01/09/13</td> </tr> </tbody> </table>				Position	Name	Signature	Date	Designed By:	CoolAutomation		01/09/13	Drawn By:	Yehuda Klein		01/09/13	Checked By:	Alexander Troitsky		01/09/13	ENG Appr.:	Alexander Troitsky
Position	Name	Signature	Date																			
Designed By:	CoolAutomation		01/09/13																			
Drawn By:	Yehuda Klein		01/09/13																			
Checked By:	Alexander Troitsky		01/09/13																			
ENG Appr.:	Alexander Troitsky		01/09/13																			
	<b>SI METRIC</b>	<b>SCALE: 1:1</b>	<b>SHEET: 1 OF: 2</b>	<b>SIZE: A3</b>	<b>Do Not Scale Drawing</b>	<b>Rev: 2</b>																