



CoolPlug
CooLinkHub
HVAC Bridge

Quick Installation Guide

Warning

Read and understand the following Safety Guidelines and Warnings to ensure a safe installation



Failure to follow WARNING may result in injury or death.

This equipment is to be installed by accredited electrician or similar technical personnel, as per these installation instructions.

Read the installation instructions before connecting the system to the power source.

All electrical work must be performed by a licensed technician, according to local regulations.

Ultimate disposal of this product should be handled according to all national laws and regulations.

Installation of the equipment must comply with local and national electrical legislation for installation of electric equipment.

Do not install the devices outdoors or exposed to direct solar radiation, water, high relative humidity or dust.

Install the equipment only in a restricted access location.

When wall mounting, be sure to fix firmly on a stable surface and in accordance to the instructions below.

When DIN rail mount fix the devices properly to the DIN rail following the instructions below.

When mounting on DIN rail inside a metallic cabinet be sure to properly connected to earth.

Unplug power when connecting the wires.

Pay attention to the polarity of power and communication cables when connecting them

Disconnect power of any bus or communication cable before connecting the system

Caution

Failure to follow CAUTION may result in serious injury, property damage or in some circumstances, even death.

Do not allow children to play with the CoolPlug or CoolLinkHub.

Do not disassemble, modify or repair the CoolPlug or CoolLinkHub, contact CoolAutomation support. Any damage caused by your modification or repair may result in an electric shock or fire.

Do not expose CoolPlug or CoolLinkHub to moisture. Water can damage the CoolPlug or CoolLinkHub, resulting in an electrical components failure, electric shock or fire.

Do not use flammable materials (e.g. hairspray or insecticide) near the CoolPlug or CoolLinkHub.

Do not clean the CoolPlug or CoolLinkHub with organic solvents such as paint thinner.

Use only a dry cloth to wipe if necessary.

The maximum voltage that can be applied to CoolLinkHub directly is 24V DC. Do not apply AC110V or AC220V to the CoolLinkHub or CoolPlug.

DO NOT INSTALL COOLINKHUB or COOLPLUG IN THE FOLLOWING LOCATIONS:

a) Where mineral oil mist or oil spray or vapor is produced, for example, in a kitchen. Plastic parts may deteriorate and fall off.

b) Where corrosive gas, such as sulfurous acid gas, is produced.

c) Near machinery emitting electromagnetic waves.

Electromagnetic waves may disturb or damage the operation of the CoolLinkHub.

d) Where flammable gas may leak, where there is carbon fiber or ignitable dust suspensions in the air, or where volatile flammable such as thinner or gasoline are handled.

Operating the CoolLinkHub or CoolPlug in such conditions can cause a fire.

e) In high temperature areas or in near any flame.

f) In moist areas, where there is exposure to water.

Contents

- 6 CoolLinkHub + CoolPlug
 - System overview
 - Network Topology
 - CoolPlug Models
- 7 CoolPlug models
- 8 Connecting CoolPlug
 - DK (Daikin) – S21
- 9 Connecting CoolPlug
 - DK (Daikin) – P1 P2
- 10 Connecting CoolPlug
 - DKS (Daikin) – Siesta
- 11 Connecting CoolPlug
 - PN/SA/TO (Panasonic | Sanyo | Toshiba)
- 12 Connecting CoolPlug FJ (Fujitsu)
 - FJ (Fujitsu) - Option 1
 - FJ (Fujitsu/General) - Option 2
- 13 Connecting CoolPlug
- 14 Connecting CoolPlug
 - ME (Mitsubishi Electric)- CN-105
- 15 Connecting CoolPlug
 - ME (Mitsubishi Electric) - 1 2
- 16 Connecting Home Automation, BMS & CoolRemote
- 17 CoolRemote App registration
- 18 CoolPlug Installation Complete
 - CoolPlug Indicators
 - CoolPlug Normal Operation
 - Determining the CoolPlug UID
 - Toggling the HVAC ON/OFF
 - Resetting the CoolPlug
- 20 Mounting options
 - CoolPlug
 - CoolLinkHub

CooLinkHub + CoolPlug

System overview

CooLinkHub + CoolPLugs is a solution for complete integration of Multi-Split and Mini-Split HVAC units. CoolPlug - HVAC designated adapter, that connects directly to the HVAC indoor unit on one side, and to CooLinkHub on the other, by PBUS Network.

CooLinkHub - protocol converter, that allows integration to any Home Automation system.

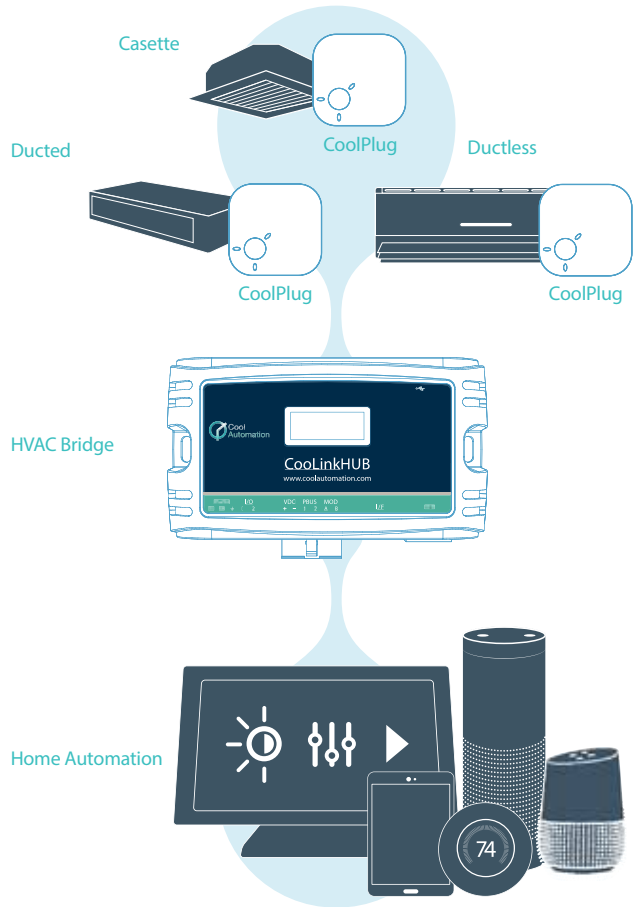

Sticker

Network Topology

PBUS is a CoolAutomation's proprietary Bus, running on shielded twisted pair cable (24AWG). PBUS utilizes free network topology ('star', 'daisy-chain', etc.) No loops allowed.

Up to 10 CoolPlug's can be connected in a single PBUS network.

CoolPlug Models

CoolPlug models are HVAC manufacturer specific. The letters on the sticker (DK, DKS, etc.) indicate the HVAC manufacturer the CoolPlug relates to.

HVAC	DK	Daikin
HVAC	DKS	Daikin Siesta Series
HVAC	PA SA TO	Panasonic Sanyo Toshiba
HVAC	FJ	Fujitsu/General
HVAC	ME	Mitsubishi Electric

Connecting CoolPlug DK (Daikin) – S21.

- 1 Connecting CoolPlug to Daikin unit**
Connect the S21 cable supplied with the CoolPlug, between the CoolPlug RJ-11 connector and the S21 port on the indoor unit's PCB. Consult HVAC manufacturer's installation manual for location of S21 on Control Board.

- 2 Connecting CoolPlug to CoolLinkHub**
Connect the signal wires of PBUS cable between CoolPlug terminals [-], [1] and [2], and CoolLinkHub terminals [VDC-], [1] and [2], respectively.

* Room temperature reading is not available with S21 interface.

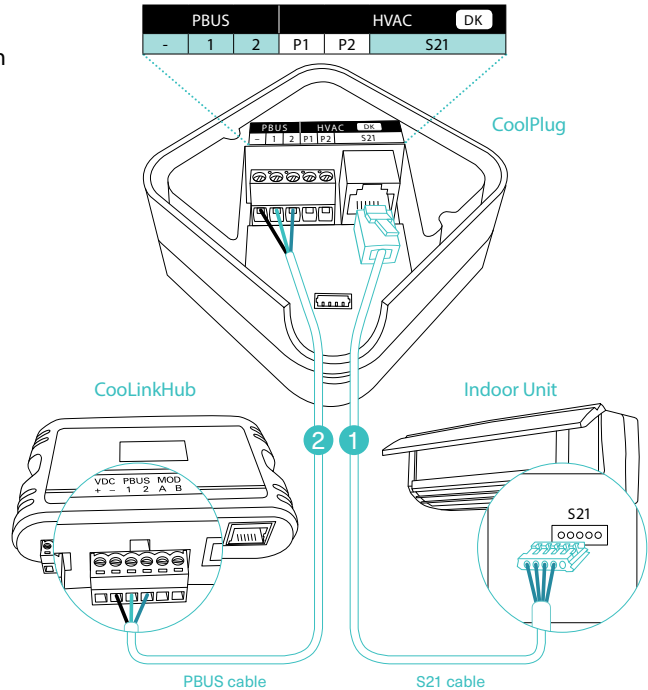

Connecting CoolPlug DK (Daikin)

DK (Daikin) – P1 P2

1 Connecting CoolPlug to Daikin unit

Connect the CoolPlug's [P1], [P2] terminals to [P1], [P2] terminals on indoor unit.*

2 Connecting CoolPlug to CoolLinkHub

Connect the signal wires of the PBUS cable coming from the [VDC-], [1] and [2] terminals on the CoolLinkHub to the corresponding [-], [1] and [2] terminals on the CoolPlug, respectively.

3 Optional: Connect the Wired Remote Controller (W.R.C.) in parallel mode.

* No polarity requirements

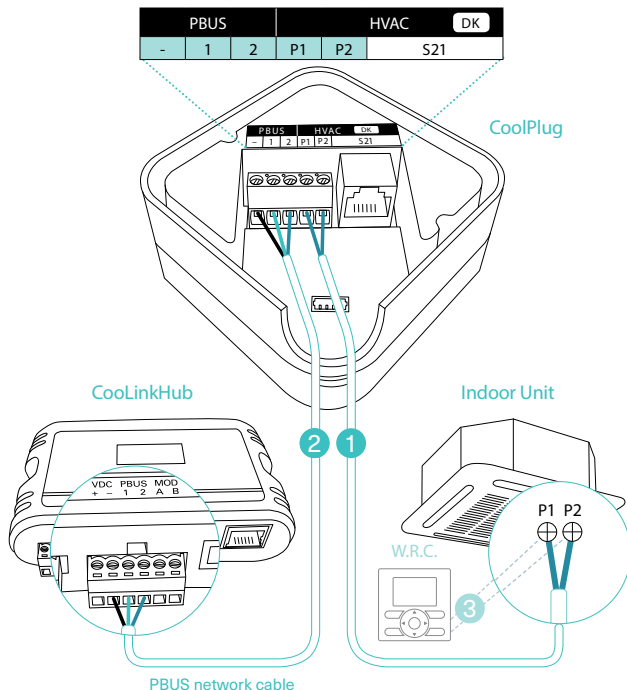

Connecting CoolPlug DKS (Daikin) - Siesta Series

1 Connecting CoolPlug HVAC Line to Daikin Siesta Indoor Unit

Connect the cable, supplied with the CoolPlug, to the port labeled “Indoor” on CoolPlug and the corresponding connector on the indoor unit.

2 Connecting CoolPlug to CoolLinkHub

Connect the signal wires of the PBUS cable, using [VDC-], [1] and [2] terminals on the CoolLinkHub, to the corresponding [-], [1] and [2] terminals on the CoolPlug.

3 Optional: Connect the wired Remote to the “W.R.C” socket on the CoolLinkNet. The Cable is supplied with the wired remote controller.

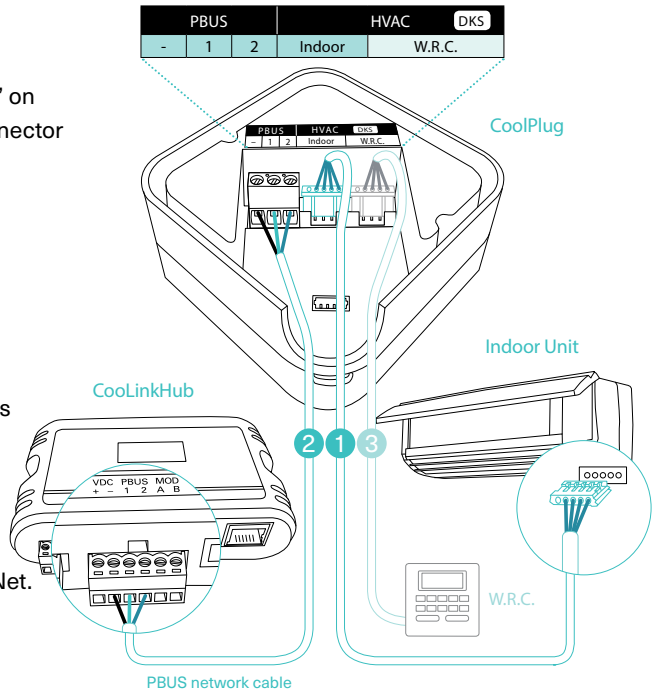

Connecting CoolPlug PN/SA/TO (Panasonic | Sanyo | Toshiba)

1 Connecting CoolPlug HVAC Line to PN/SA/TO Indoor Unit

Connect the CoolPlug's [A], [B] terminals to [A], [B] terminals on indoor unit.

* To connect to Panasonic indoor unit use R1 R2 terminals.

2 Connecting CoolPlug to CoolLinkHub

Connect the signal wires of the PBUS cable coming from the [VDC-], [1] and [2] terminals on the CoolLinkHub to the corresponding [-], [1] and [2] terminals on the CoolPlug.

3 Optional: Connect the Wired Remote Controller (W.R.C.)

* No polarity requirements

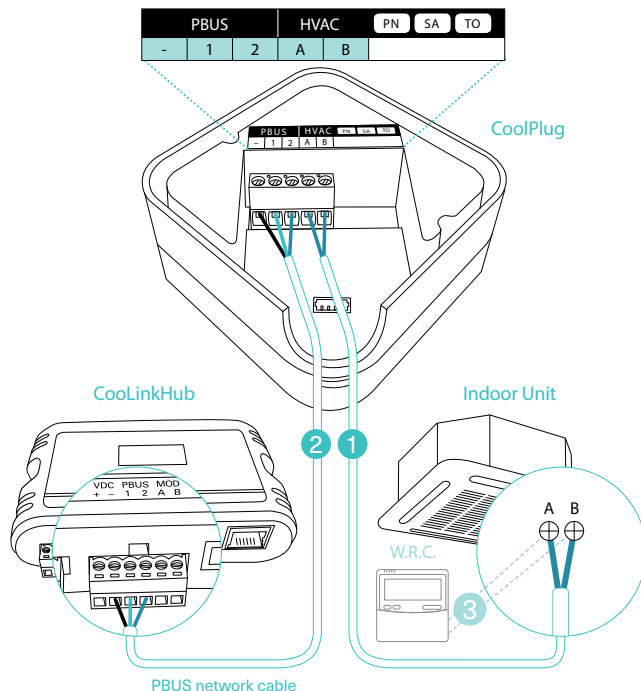

Connecting CoolPlug FJ (Fujitsu/General) - Option 1*

1 Connecting CoolPlug HVAC Line to Fujitsu Indoor Unit

Connect the CoolPlug's [W1], [B1], [R1] terminals to corresponding terminals on the indoor unit, keeping the wire colors consistency.

2 Connecting CoolPlug to CoolLinkHub

Connect the signal wires of the PBUS cable, using [VDC-], [1] and [2] terminals on the CoolLinkHub, to the corresponding [-], [1] and [2] terminals on the CoolPlug.

3 Optional: Connect the Wired Remote Controller (W.R.C.)

- * For indoors that work with APG000 or compatible W.R.C. models.
- * Reset power, once CoolPlug is installed

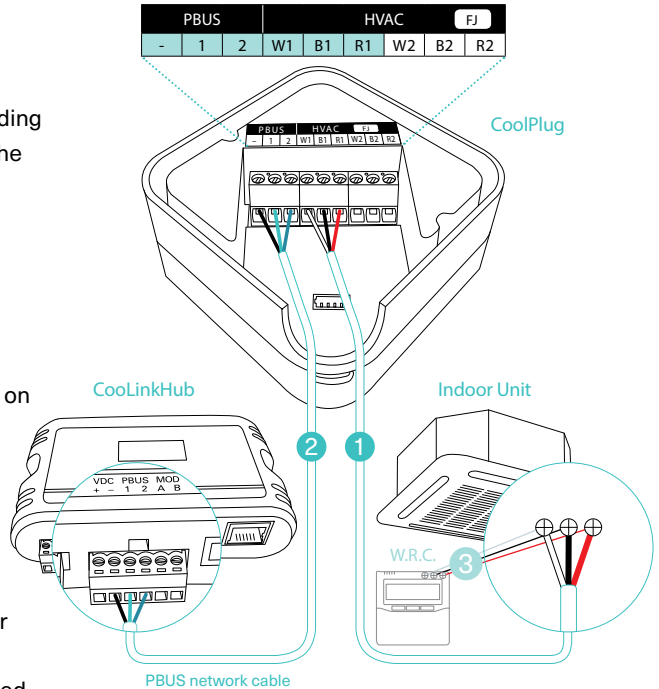

Connecting CoolPlug FJ (Fujitsu/General) - Option 2

1 Connecting CoolPlug to CoolLinkHub

Connect the signal wires of the PBUS cable coming from the [VDC-], [1] and [2] terminals on the CoolLinkHub to the corresponding [-], [1] and [2] terminals on the CoolPlug.

2 Connecting CoolPlug HVAC Line to Fujitsu Indoor Unit

Connect the CoolPlug's [W1], [B1], [R1] terminals to indoor unit. Consult HVAC manufacturer's installation manual for instructions.

3 Optional: Connect the CoolPlug's [W2], [B2], [R2] terminals to Fujitsu W.R.C.

- * For indoors that work with EZ-099 or compatible type wired remote controllers.
- * Reset power, once CoolPlug is installed

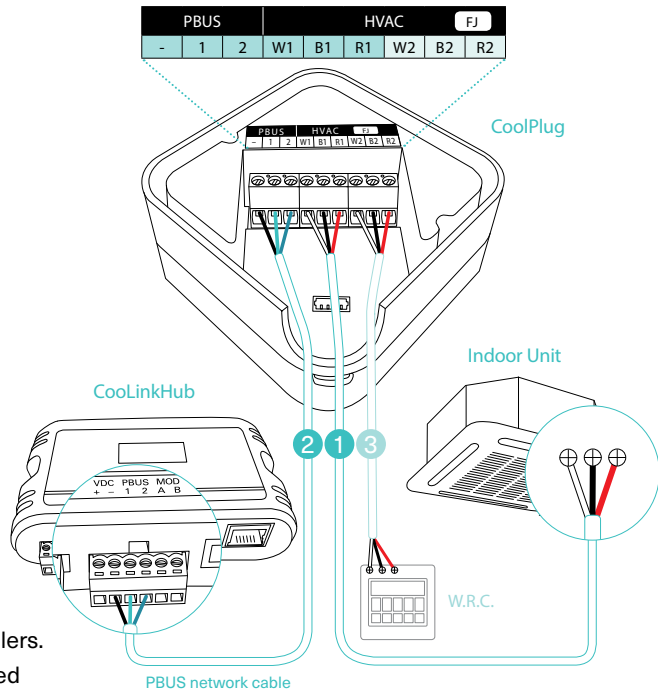

Connecting CoolPlug ME (Mitsubishi Electric)

Option 1 – CN-105

1 Connecting CoolPlug HVAC Line to Mitsubishi Indoor Unit

Connect the ME CN-105 cable, supplied with the CoolPlug, between the CoolPlug RJ-11 connector and the CN-105 port on the indoor unit's Control Board. Consult HVAC manufacturer's installation manual for location of CN-105 on Control Board.

2 Connecting CoolPlug to CoolLinkHub

Connect the signal wires of the PBUS cable, using [VDC-], [1] and [2] terminals on the CoolLinkHub, to the corresponding [-], [1] and [2] terminals on the CoolPlug.

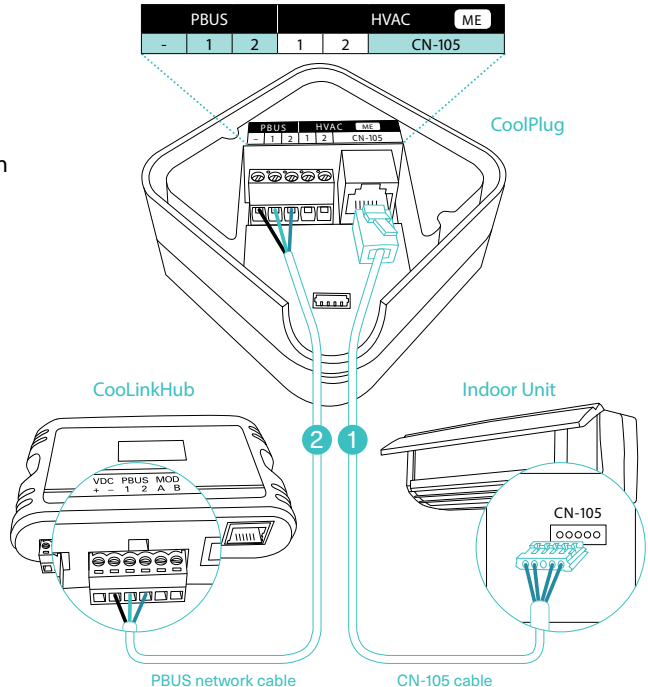

Connecting CoolPlug ME (Mitsubishi Electric)

Option 2 – [1] [2]

1 Connecting CoolPlug HVAC Line to Mitsubishi Indoor Unit

Connect the CoolPlug's HVAC [1], HVAC [2] terminals to [1], [2] terminals on indoor unit. Consult HVAC manufacturer's installation manual for location of [1] and [2].

2 Connecting CoolPlug to CoolLinkHub

Connect the signal wires of the PBUS cable, using [VDC-], [1] and [2] terminals on the CoolLinkHub to the corresponding [-], [1] and [2] terminals on the CoolPlug.

3 Optional: Connect the Wired Remote Controller (W.R.C.).

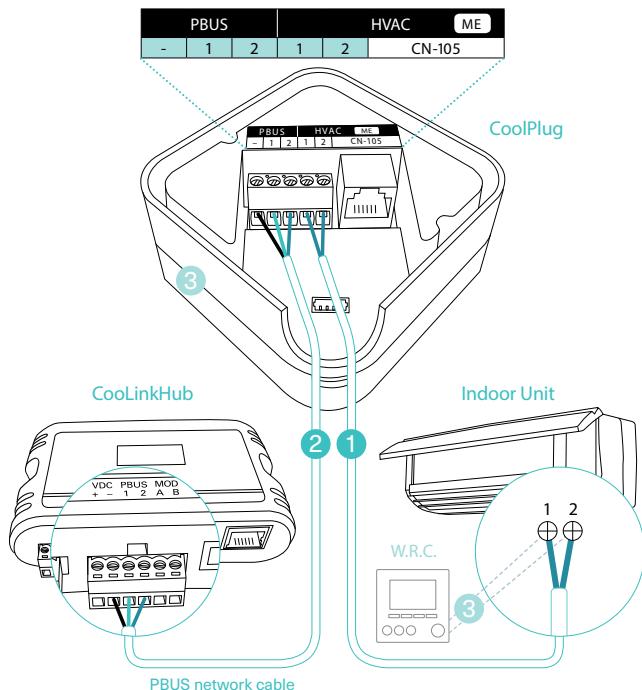

Connecting Home Automation, BMS & CoolRemote

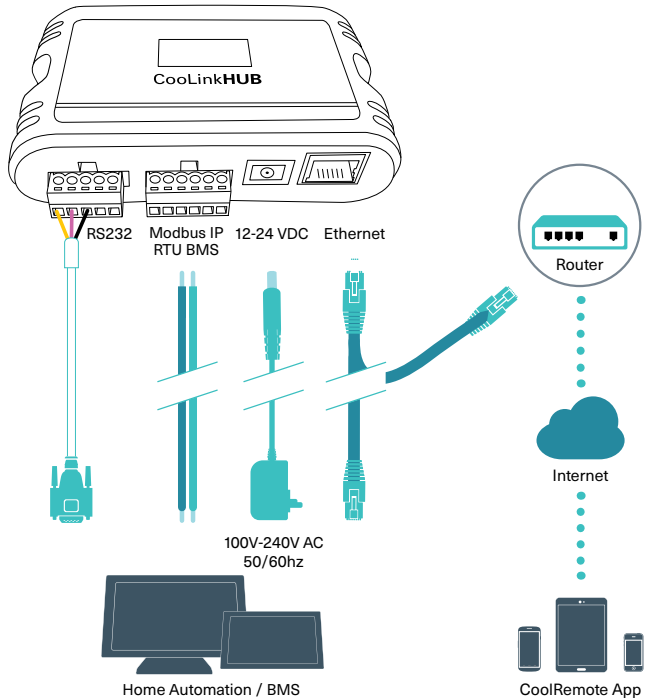

CoolRemote App

Connect the device to the Internet for registration and setup.

Option A - Automatic

- 1 Scan the QR code from the type label to auto fill-in all the CoolLinkHub details for CoolRemote App.



- 2 Register your user-name (e-mail) and password to remotely control and monitor all your HVAC units.

Option B - Manual

- 1 Go to: <https://coolremote.net/register>
Enter CoolLinkHub SN number and PIN code, printed on the sticker.

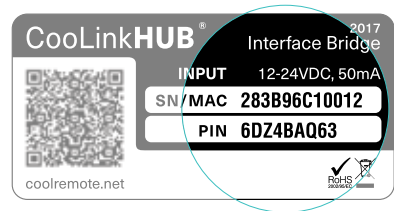

- 2 Register your user-name (e-mail) and password to remotely control and monitor your HVAC units.

CoolPlug Installation Complete

CoolPlug Indicators

The three LEDs that surround the CoolPlug push-button provide information about the CoolPlug configuration and status. After applying power to CoolPlug the Firmware version is displayed by flashing LEDs followed by the operation state of the system.

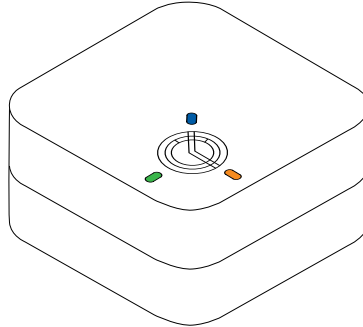

CoolPlug Normal Operation

In normal operation the blue LED blinks infrequently. The green and orange LEDs are not lit.

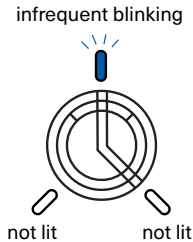

	Normal operation	Problems	
	LED OFF	LED ON	LED Blinking
Green	HVAC Line OK	HVAC Line not connected	HVAC Line errors
Amber	PBUS OK	PBUS not connected	PBUS errors
Blue	Blinks infrequently twice — HVAC is ON	—	
	Blinks infrequently — HVAC is OFF		

Determining the CoolPlug UID

The CoolPlug UID is flashed after one 'Short' press on the CoolPlug push-button.

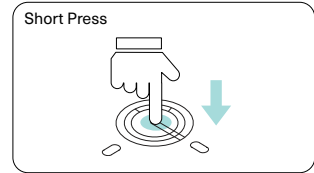

Toggling the HVAC ON/OFF

Toggle the HVAC state ON/OFF with one 'Long' press on the CoolPlug push-button.

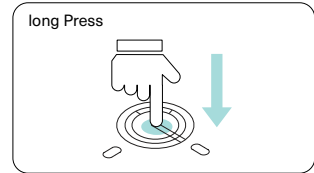

Resetting the CoolPlug

Reset the CoolPlug with one 'Short' press followed by one 'Continuous' press on the CoolPlug push-button.

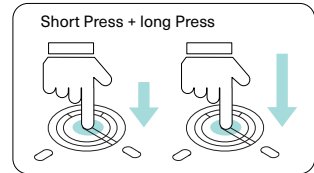

Mounting the CoolPlug

1 On Metal Surface

The CoolPlug back plate has two magnets that allow you to mount it on any metal surface.

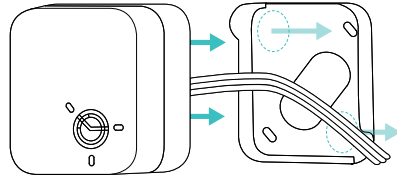

2 On Wall

Attach the CoolPlug back plate to the wall using screws as shown. The wires can be fed through the hole in the center of the cover or from the side as shown.

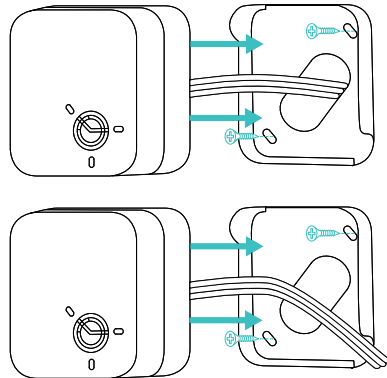

3 On DIN rail

Use back plate for DIN rail to attach it to the DIN rail utilizing magnets.

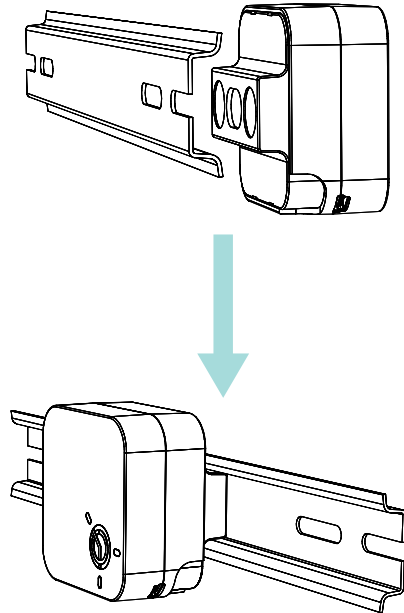

Need more help?

Visit us: <http://coolautomation.com/support>

Email us: support@coolautomation.com

